

LIMITEX AP

HAZARDOUS AREAS

Cross limit switch



Explosion proof cross position limit switch. Rugged and reliable, Limitex AP is designed to control the movement of overhead travelling cranes, hoists and complex machine tools operating in potentially explosive areas.

FEATURES

- Positive opening NC contacts for safety functions.
- Mechanical life of switches: 1 million operations.
- Operation frequency: 3600 operations/hour max.
- IP protection degree: Limitex AP is classified IP66.
- Extreme temperature resistance: -40°C to +60°C.
- It features rugged external enclosure made of G20 cast iron and cross rod support made of zinc alloy. Internal components are made of materials which guarantee long mechanical life and continuous performance.
- All materials and components used are wear resistant and guarantee protection of the unit against water and dust.

OPTIONS

- 2 or 4 snap action switches with 1NO+1NC change-over contacts.
- Cross rods move to 3 or 4 maintained positions, with movement every 90°.
- Modular adapter with fixing points.

CERTIFICATIONS

- CE marking.
- Atex certification EN 60079-0:2009, EN 60079-1:2007, EN 60079-31:2009.
- Conformity to Standards IECEx IEC 60079-0:2011, IEC 60079-1:2007-04 and IEC 60079-31:2008.

CERTIFICATIONS

Conformity to Atex Standards	EN 60079-0:2009 Explosive atmospheres - Equipment - General requirements
	EN 60079-1:2007 Explosive atmospheres - Equipment protection by flameproof enclosures "d"
	EN 60079-31:2009 Explosive atmospheres - Equipment dust ignition protection by enclosure "t"
Conformity to IECEx Standards	IEC 60079-0:2011 Explosive atmospheres - Equipment - General requirements
	IEC 60079-1:2007-04 Explosive atmospheres - Equipment protection by flameproof enclosures "d"
Atex Certification	INERIS 13ATEX0020X
IECEx Certification	IECEx INE 13.0051X
Certification for group I, IIA, IIB and IIC with the marks*	MINING: I M2 Ex d I Mb (ATEX) Ex d I Mb (IECEx)
	GAS Zone 1 and 2: II2G Ex d IIB T6 Gb or Ex d IIC T6 Gb (ATEX) Ex d IIB T6 or Ex d IIC T6 Gb (IECEx)
	DUST Zone 21 and 22: II2D Ex tb IIIC T85°C Db IP66 (ATEX) Ex tb IIC T85°C Db IP66 (IECEx)
	GAS & DUST: II2GD Ex d IIB or IIC T6 Gb Ex tb IIC T85°C Db IP66
Conformity to Community Directives	2014/35/UE Low Voltage Directive
	2006/42/CE Machinery Directive
Conformity to CE Standards	EN 60204-1 Safety of machinery - Electrical equipment of machines
	EN 60947-1 Low-voltage switchgear and controlgear
	EN 60947-5-1 Low-voltage switchgear and controlgear - Control circuit devices and switching elements - Electromechanical control circuit devices
	EN 60529 Degrees of protection provided by enclosures
Markings and homologations	CE  IEC IECEx

GENERAL SAFETY SPECIFICATIONS

Maximum power supply	250 Vac
Maximum current intensity	3 A
Maximum dissipated power	2 Watt
Rated frequency	50 / 60 Hz

GENERAL TECHNICAL SPECIFICATIONS

Operational ambient temperature	-40°C/+60°C
Protection degree	IP 66
Operation frequency	3600 operations/hour max
Cable entry	Nr. 2 M20x1.5 (standard) **
	Nr. 2 M25x1.5 (available on request) **
	Nr. 2 ½ NPT (available on request) **

* The user is responsible for choosing the proper limit switch protection type, group and maximum case temperature. The user is also responsible for the correct installation, connection to the electrical network and use and maintenance of the electrical devices.

** Featuring plug, when mounting only one cable clamp.

LIMITEX AP WITH 2 MICROSWITCHES

TECHNICAL SPECIFICATIONS OF THE MICROSWITCHES

Utilisation category	AC 15
Rated operational current	3 A
Rated operational voltage	250 Vac
Rated thermal current	10 A
Rated insulation voltage	300 Vac
Mechanical life	1x10 ⁶ operations
Connections	Screw-type terminals
Wires	1x2.5 mm ² , 2x1.5 mm ² (UL - (c)UL: use 60°C or 75°C copper (CU) conductor and wire 16-18 AWG)
Tightening torque	0.8 Nm
Microswitch type	Double break, snap action
Contacts	1NO+1NC (All NC contacts are of the positive opening operation type \ominus)

Scheme

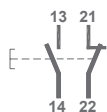

LIMITEX AP WITH 2 MICROSWITCHES - MAXIMUM ACTUATING DIMENSIONS

T-type rod - Cross rod with 3 maintained positions

- Pre-travel angle for rotation contact operation: 70°-49°
- Maximum rotation angle for each maintained position: 90°
- Average angle for the mechanical tripping: 48°

Rod - Rod and Roller

- Pre-travel angle for rotation contact operation: 24°
- Maximum rotation angle: 65°

Cross rod with 4 maintained positions

- Pre-travel angle for rotation contact operation: 49°
- Maximum rotation angle for each maintained position: 90°
- Average angle for the mechanical tripping: 48°
- Maintained positions each: 90°

In order to ensure proper operations, the dimensions shall not be increased; anyhow, they can be decreased, taking into account that the closer the impact point is to the center of the head, the higher the impact and the mechanical wear of rod and shaft are. **IMPORTANT:** the maximum impact speed is 1.35 m/s, referring to the ideal impact points showed in the drawing.

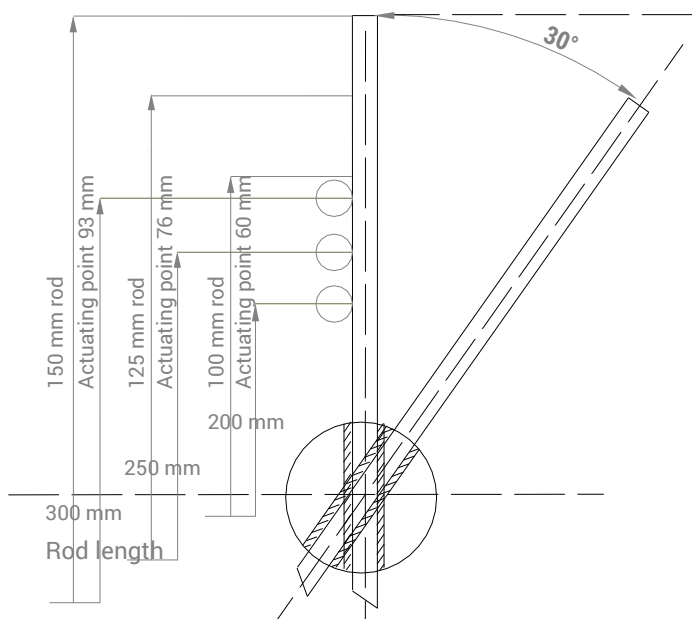

LIMITEX AP WITH 4 MICROSWITCHES

TECHNICAL SPECIFICATIONS OF THE MICROSWITCHES

Rated operational current	16 A at 250 Vac
Rated operational voltage	500 Vac
Rated thermal current	10 A
Rated insulation voltage	300 Vac
Mechanical life	10x10 ⁶ operations
Connections	Screw-type terminals
Wires	1x2.5 mm ² , 2x1.5 mm ²
Microswitch type	Snap action
Contacts	1NO+1NC

Scheme

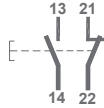

LIMITEX AP WITH 4 MICROSWITCHES - OPERATION ANGLES

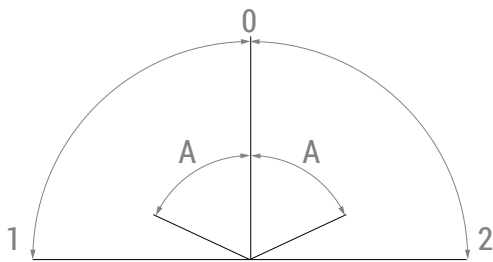

0 - Reset position

A - Microswitch working angle: 65°

1 - Maximum left handed operation: 90°

2 - Maximum right handed operation: 90°





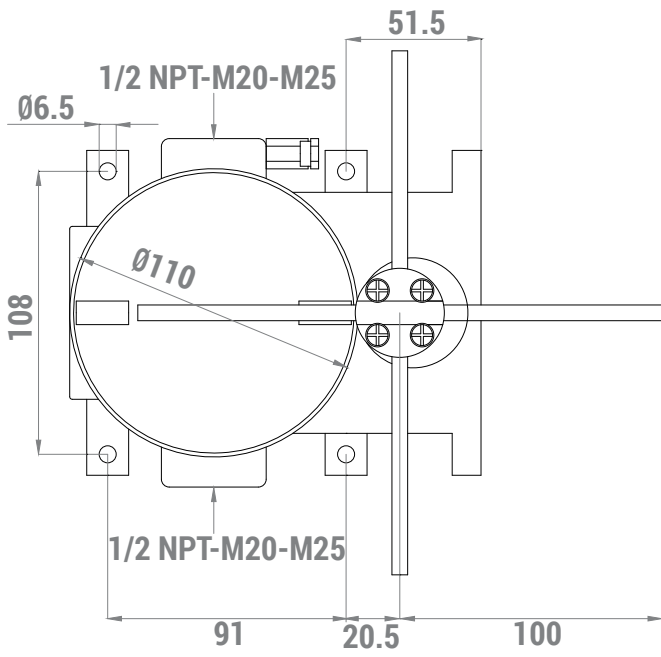
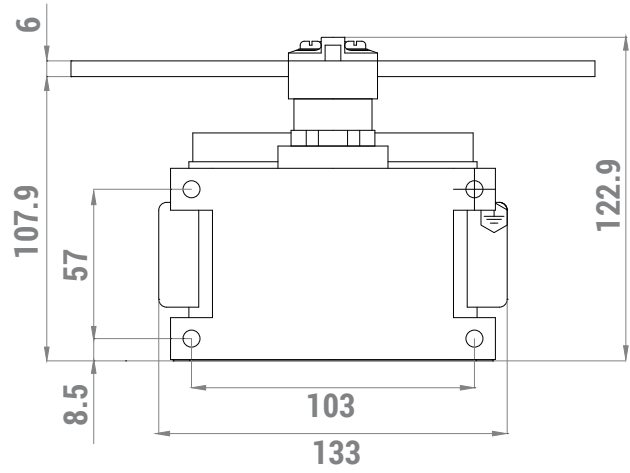
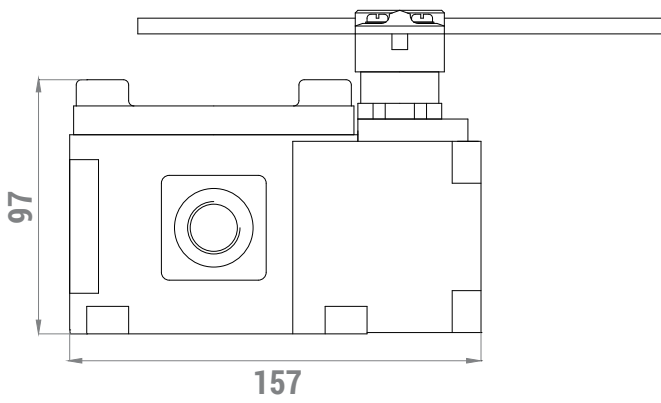

The end of round of the "cross bar" limit switches have no limit stop (they can rotate around 360°).

OVERALL DIMENSIONS (mm)

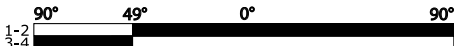
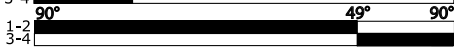
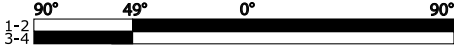

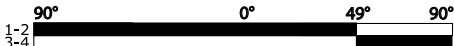
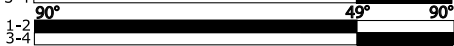
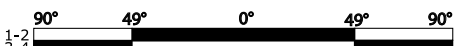
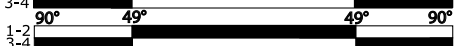
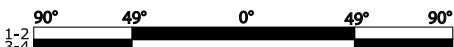
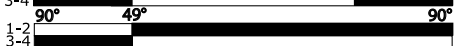
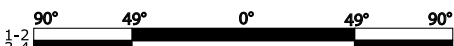
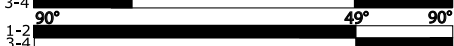

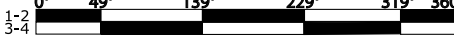

LIMIT SWITCHES LIMITEX AP WITH 2 MICROSWITCHES

Limit switches are equipped with 1NO+1NC snap action switches 

Actuating travel	Positions	Rod	Code
	3 maintained	"T" type	EX33710100
	3 maintained	Cross	EX33710200
	3 maintained	"T" type	EX33711100
	3 maintained	Cross	EX33711200
	3 maintained	"T" type	EX33712100
	3 maintained	Cross	EX33712200
	3 maintained	"T" type	EX33713100
	3 maintained	Cross	EX33713200
	3 maintained	"T" type	EX33714100
	3 maintained	Cross	EX33714200
	3 maintained	"T" type	EX33715100
	3 maintained	Cross	EX33715200
	4 maintained	Cross	EX33750100
	4 maintained	Cross	EX33751100
	4 maintained	Cross	EX33752100
	4 maintained	Cross	EX33752100

LIMIT SWITCHES LIMITEX AP WITH 4 MICROSWITCHES

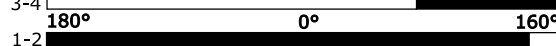
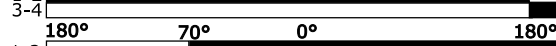
Limit switches are equipped with 1NO+1NC snap action switches 

Actuating travel	Rod length	Code
	200 mm	EX26755100
		
		
		
	200 mm	EX26755200
